

Article number: 2301072862

Description: E+G Handwheel
VDS.200+IR-A24

Measures

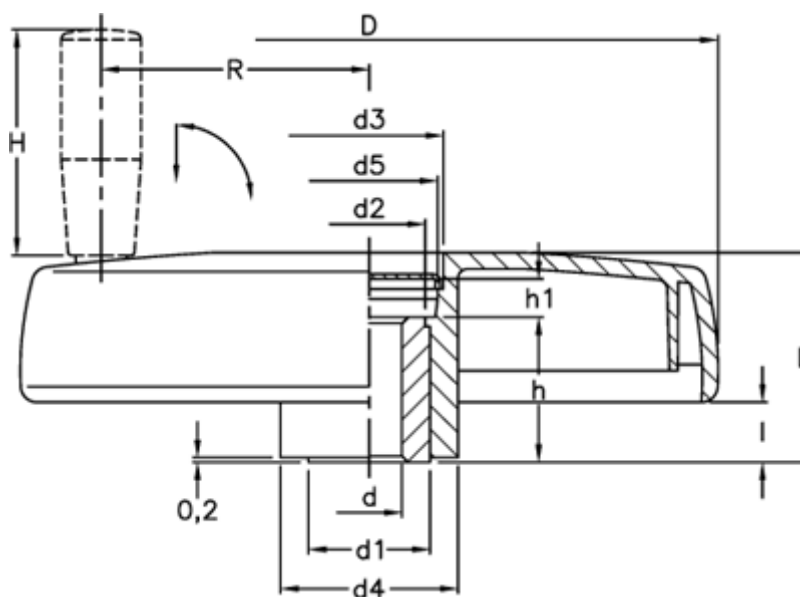

C (N m) = 320	H = 90
D = 200	h = 36
d1 = 40	h1 = 13.0
d2 = 38.0	l = 14.0
d3 = 44.0	L = 53
d4 = 50	L (J) = 27
d5 = 40.0	R = 81
d H7 = 24	